



POWERING INNOVATION THAT DRIVES HUMAN ADVANCEMENT

© 2025 ANSYS, Inc. or its affiliated companies  
Unauthorized use, distribution, or duplication is prohibited.

## Getting Started with EMIT - Tutorial 8



ANSYS, Inc.  
Southpointe  
2600 Ansys Drive  
Canonsburg, PA 15317  
[ansysinfo@ansys.com](mailto:ansysinfo@ansys.com)  
<https://www.ansys.com>  
(T) 724-746-3304  
(F) 724-514-9494

Release 2025 R1  
January 2025

ANSYS, Inc. and  
ANSYS Europe,  
Ltd. are UL  
registered ISO  
9001:2015  
companies.

## Copyright and Trademark Information

© 1986-2025 ANSYS, Inc. Unauthorized use, distribution or duplication is prohibited.

ANSYS, Ansys Workbench, AUTODYN, CFX, FLUENT and any and all ANSYS, Inc. brand, product, service and feature names, logos and slogans are registered trademarks or trademarks of ANSYS, Inc. or its subsidiaries located in the United States or other countries. ICEM CFD is a trademark used by ANSYS, Inc. under license. All other brand, product, service and feature names or trademarks are the property of their respective owners. FLEXlm and FLEXnet are trademarks of Flexera Software LLC.

## Disclaimer Notice

THIS ANSYS SOFTWARE PRODUCT AND PROGRAM DOCUMENTATION INCLUDE TRADE SECRETS AND ARE CONFIDENTIAL AND PROPRIETARY PRODUCTS OF ANSYS, INC., ITS SUBSIDIARIES, OR LICENSORS. The software products and documentation are furnished by ANSYS, Inc., its subsidiaries, or affiliates under a software license agreement that contains provisions concerning non-disclosure, copying, length and nature of use, compliance with exporting laws, warranties, disclaimers, limitations of liability, and remedies, and other provisions. The software products and documentation may be used, disclosed, transferred, or copied only in accordance with the terms and conditions of that software license agreement.

ANSYS, Inc. and ANSYS Europe, Ltd. are UL registered ISO 9001: 2015 companies.

## U.S. Government Rights

For U.S. Government users, except as specifically granted by the ANSYS, Inc. software license agreement, the use, duplication, or disclosure by the United States Government is subject to restrictions stated in the ANSYS, Inc. software license agreement and FAR 12.212 (for non-DOD licenses).

## Third-Party Software

See the legal information in the product help files for the complete Legal Notice for Ansys proprietary software and third-party software. If you are unable to access the Legal Notice, please contact ANSYS, Inc.

## Conventions Used in this Guide

Please take a moment to review how instructions and other useful information are presented in this documentation.

- Procedures are presented as numbered lists. A single bullet indicates that the procedure has only one step.
- Bold type is used for the following:
  - Keyboard entries that should be typed in their entirety exactly as shown. For example, “**copy file1**” means you must type the word **copy**, then type a space, and then type **file1**.
  - On-screen prompts and messages, names of options and text boxes, and menu commands. Menu commands are often separated by greater than signs (>). For example, “click **HFSS > Excitations > Assign > Wave Port.**”
  - Labeled keys on the computer keyboard. For example, “Press **Enter**” means to press the key labeled **Enter**.
- Italic type is used for the following:
  - Emphasis.
  - The titles of publications.
  - Keyboard entries when a name or a variable must be typed in place of the words in italics. For example, “**copy filename**” means you must type the word **copy**, then type a space, and then type the name of the file.
- The plus sign (+) is used between keyboard keys to indicate that you should press the keys at the same time. For example, “Press Shift+F1” means to press the **Shift** key and, while holding it down, press the **F1** key also. You should always depress the modifier key or keys first (for example, Shift, Ctrl, Alt, or Ctrl+Shift), continue to hold it/them down, and then press the last key in the instruction.

**Accessing Commands:** *Ribbons, menu bars, and shortcut menus* are three methods that can be used to see what commands are available in the application.

- The *Ribbon* occupies the rectangular area at the top of the application window and contains multiple tabs. Each tab has relevant commands that are organized, grouped, and labeled. An example of a typical user interaction is as follows:

"Click **Schematic > Line**"

This instruction means that you should click the **Line** command on the **Schematic** ribbon tab. An image of the command icon, or a partial view of the ribbon, is often included with the instruction.

- The *menu bar* (located above the ribbon) is a group of the main commands of an application arranged by category such File, Edit, View, Project, etc. An example of a typical user interaction is as follows:

"On the **File** menu, click the **Open Examples** command" means you can click the **File** menu and then click **Open Examples** to launch the dialog box.

- Another alternative is to use the *shortcut menu* that appears when you click the right-mouse button. An example of a typical user interaction is as follows:

"Right-click and select **Assign Excitation> Wave Port**" means when you click the right-mouse button with an object face selected, you can execute the excitation commands from the shortcut menu (and the corresponding sub-menus).

### Getting Help: Ansys Technical Support

For information about Ansys Technical Support, go to the Ansys corporate Support website, <http://www.ansys.com/Support>. You can also contact your Ansys account manager in order to obtain this information.

All Ansys software files are ASCII text and can be sent conveniently by e-mail. When reporting difficulties, it is extremely helpful to include very specific information about what steps were taken or what stages the simulation reached, including software files as applicable. This allows more rapid and effective debugging.

### Help Menu

To access help from the Help menu, click **Help** and select from the menu:

- **[product name] Help** - opens the contents of the help. This help includes the help for the product and its *Getting Started Guides*.
- **[product name] Scripting Help** - opens the contents of the *Scripting Guide*.
- **[product name] Getting Started Guides** - opens a topic that contains links to Getting Started Guides in the help system.

### Context-Sensitive Help

To access help from the user interface, press **F1**. The help specific to the active product (design type) opens.

You can press **F1** while the cursor is pointing at a menu command or while a particular dialog box or dialog box tab is open. In this case, the help page associated with the command or open dialog box is displayed automatically.

# Table of Contents

<b>Table of Contents</b> .....	<b>Contents-1</b>
<b>1 - Introduction</b> .....	<b>1-1</b>
Key Concepts .....	1-1
<b>2 - Model Setup</b> .....	<b>2-1</b>
<b>3 - Building the Design</b> .....	<b>3-1</b>
<b>4 - Running the Initial Simulation</b> .....	<b>4-1</b>
<b>5 - Coupling</b> .....	<b>5-1</b>

# 1 - Introduction

The focus of this tutorial is exploring an IoT Module example using EMIT's personal library models and desense results metrics.

## Key Concepts

- Importing and using personal library models
- Exploring EMIT's desense results metrics

## 2 - Model Setup

Before building the model for this tutorial, perform the following steps to populate the personal library with some pre-made models.

First, select **Tools > Options > General Options**. Expand **General** options in the tree and select **Directories**. The *PersonalLib* Directory is where all personal libraries and elements created will be stored. Either change this to something you'll easily remember, or take note of the current directory before performing the next steps.

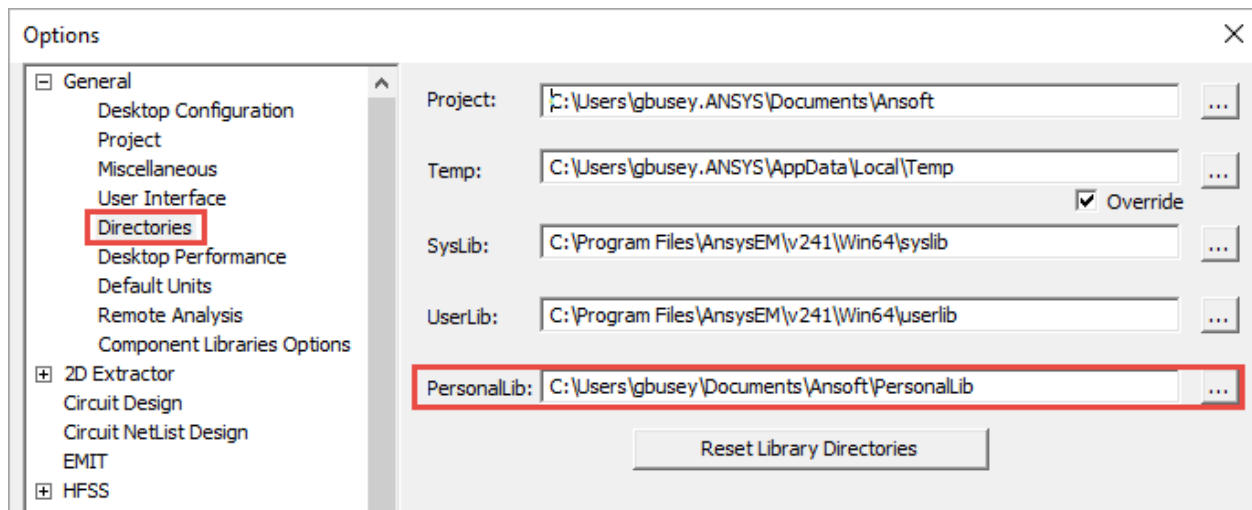

In Windows File Explorer, navigate to [AEDT Installation Directory]\Win64\ Examples\ EMIT\ Tutorials\Tutorial 8.

In this folder, you will find an .aclb file and an .aslb file. Copy these files into the PersonalLib directory noted earlier.

### Important:

If Ansys Electronics Desktop is still open, you must restart it in order to update the Component Libraries with the new models added to the personal library.

In AEDT, select **File > Open Examples**. Navigate to EMIT \Tutorials \Tutorial 8 and select the **IoT\_Module** file. Select a location to extract this archive file and click **Open**.

The **Restore Archive** window appears, with a progress bar. It may take a few moments to restore the archive. Once the restoration has completed, close this window.



Verify that the project contains 3 designs:

- 2 HFSS designs named Baseline and Shielded
- 1 EMIT design named IoT\_Module\_Solved

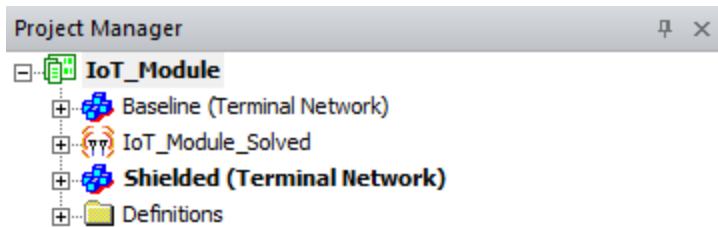

**Note:**

The Shielded design is an iteration on the Baseline design with added shielding, Via Fences, etc. added throughout. Feel free to explore both designs in HFSS.

Next, verify that the **Component Libraries** window contains the models copied to the PersonalLib directory. They should appear under **Personal Libraries**:

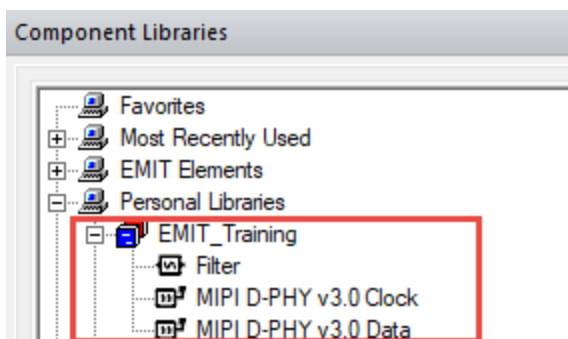

**Note:**

If the **Component Libraries** window is not visible, enable it one of two ways:

- From the **View** menu, select **Component Libraries**.
- From the **View** ribbon, select **Docking Windows > Component Libraries**.

## 3 - Building the Design

Create a new EMIT design within the current project by navigating to the **Desktop** ribbon and clicking **EMIT**.

In the **Project Manager**, a new design called **EMIT Design1** appears.

**Note:**

If an **Add Coupling Link** window appears, click **Cancel**. Coupling will be covered later in the tutorial.

Open **EMIT Design1** by double-clicking its name.

Next, insert the emitters added to the personal library into the design. From the **Component Libraries** window, expand **Personal Libraries**. Locate **MIPI D-PHY v3.0 Clock** and **MIPI D-PHY v3.0 Data**. Drag and drop one instance of each into the design:

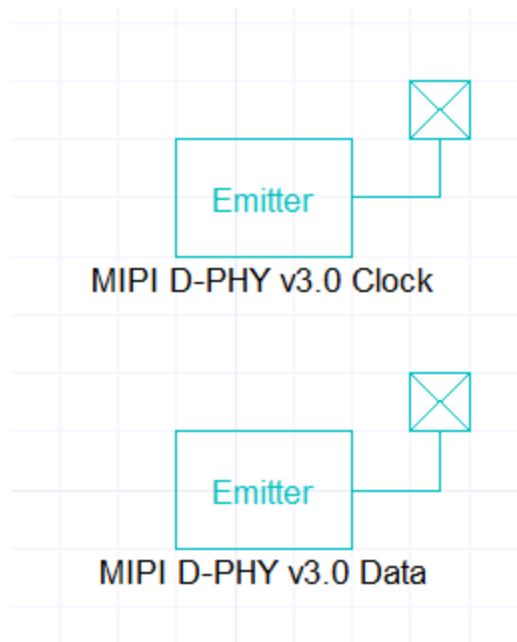

Next, place a WiFi radio in the design. In the **Component Libraries** window, expand **EMIT Elements > Radios > Commercial Unlicensed Systems > WiFi**. Place one instance of **WiFi – 802.11-2012** into the design.

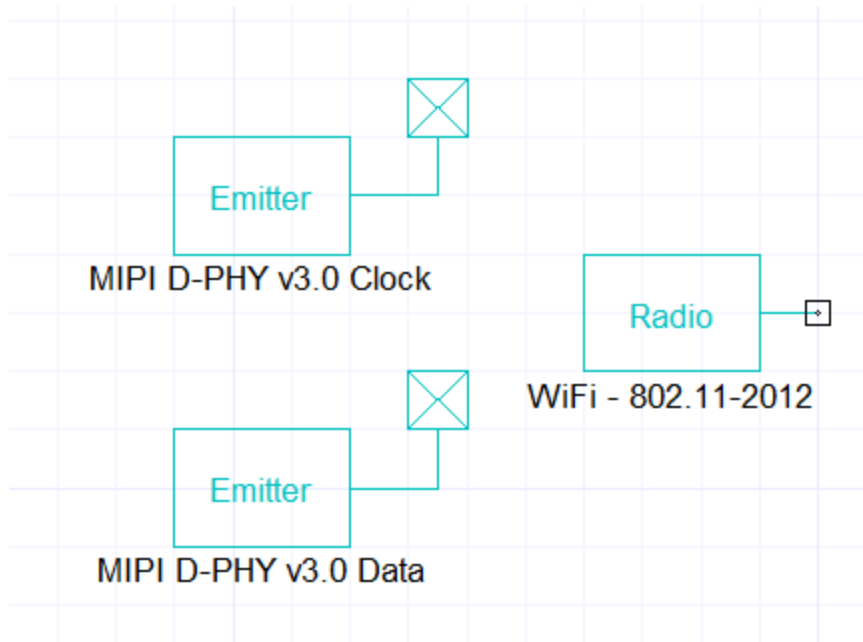

From the **Schematic** ribbon, click **Antenna**. This automatically connects an antenna to the WiFi radio:

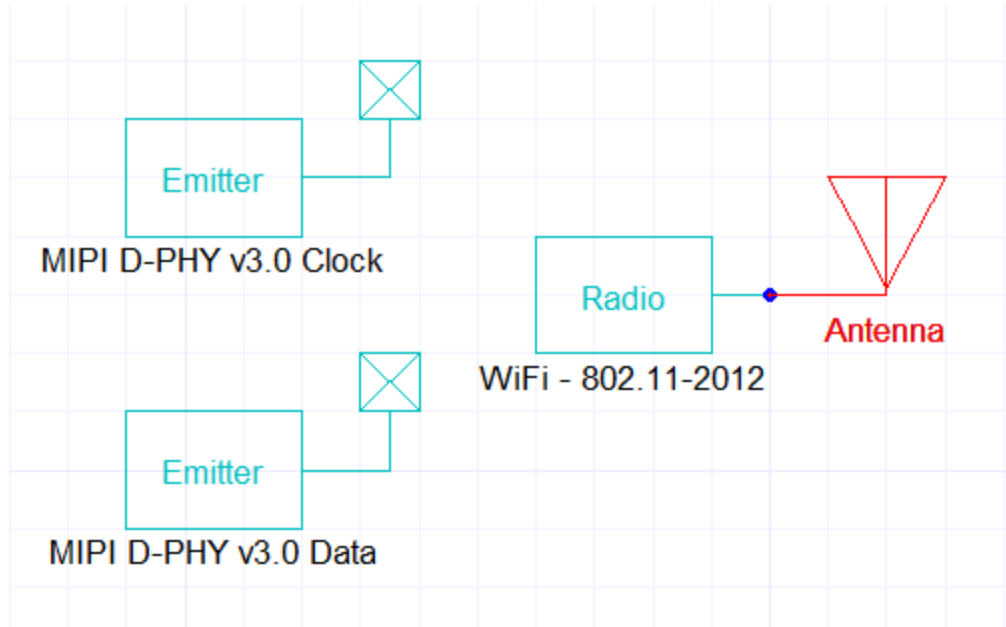

Next, configure the emitters and radio.

Right-click the **MIPI D-PHY v3.0 Clock** emitter and select **Configure**. This tutorial's first simulation will only evaluate the HS Clock 80 Mbps data rate, so deselect all of the other check boxes:

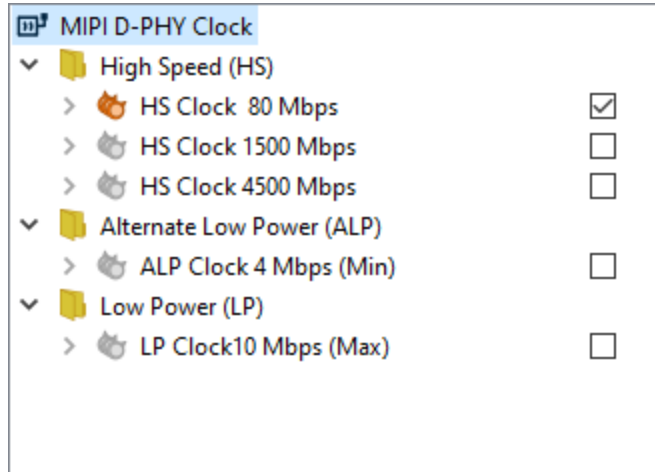

Right-click the **MIPI D-PHY v3.0 Data** emitter and select **Configure**. Again, deselect all check boxes except HS Clock 80 Mbps:

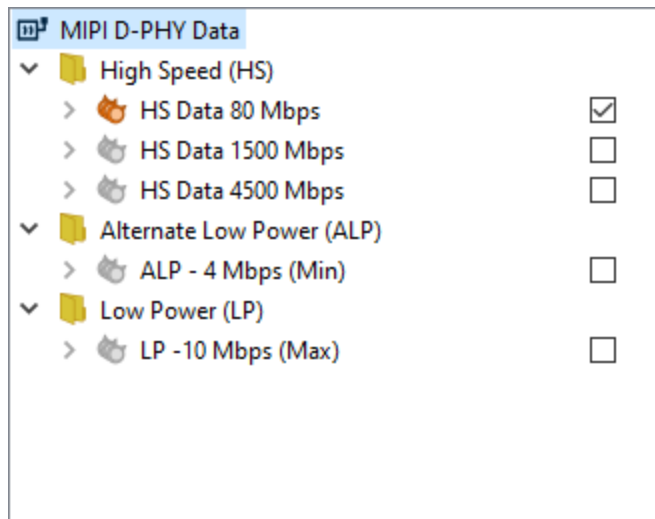

Right-click the **WiFi** radio and select **Configure**. Expand the **HR-DSSS** folder and enable the **HR-DSSS Rx – Ch 1-13** band.

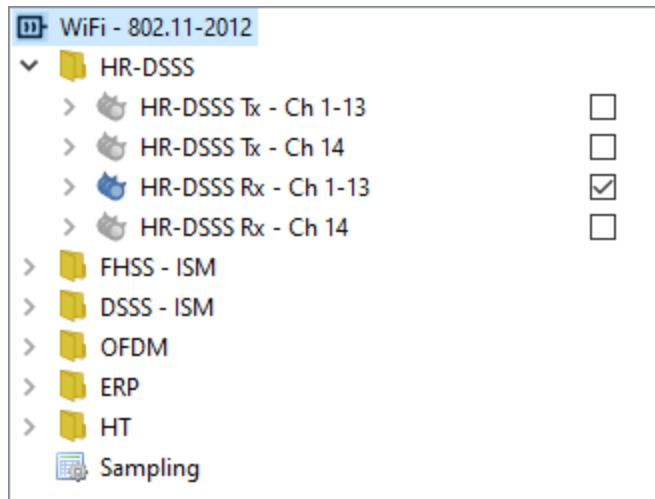

## 4 - Running the Initial Simulation

Before running a simulation of the design, save the project.

Next, open the simulation window one of two ways:

- From the **Simulation** ribbon, click **Analyze**.
- From the **Project Manager**, right-click **EMIT Design1** and select **Analyze**.

Once the window has opened, click **Run**.

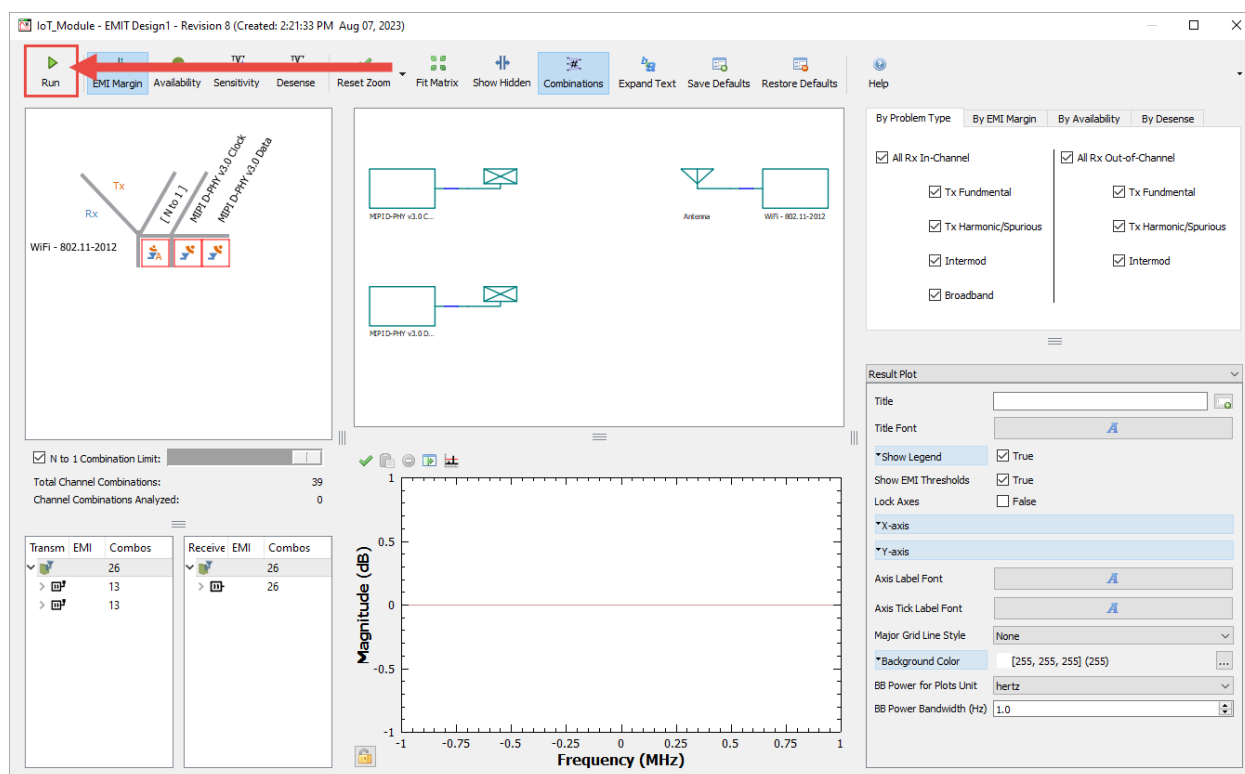

After the simulation runs, the scenario matrix updates with color codes:

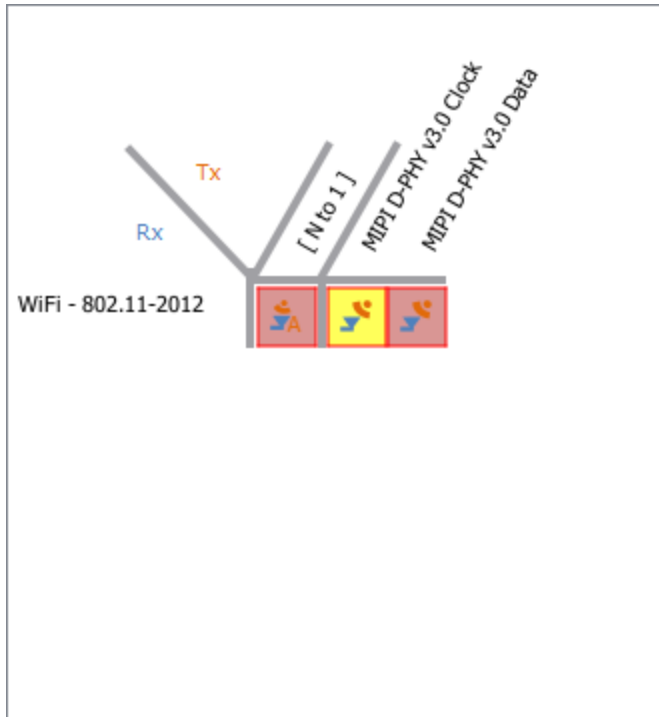

The threshold values for the color coding can be changed in the **By EMI Margin** tab at the upper-right.

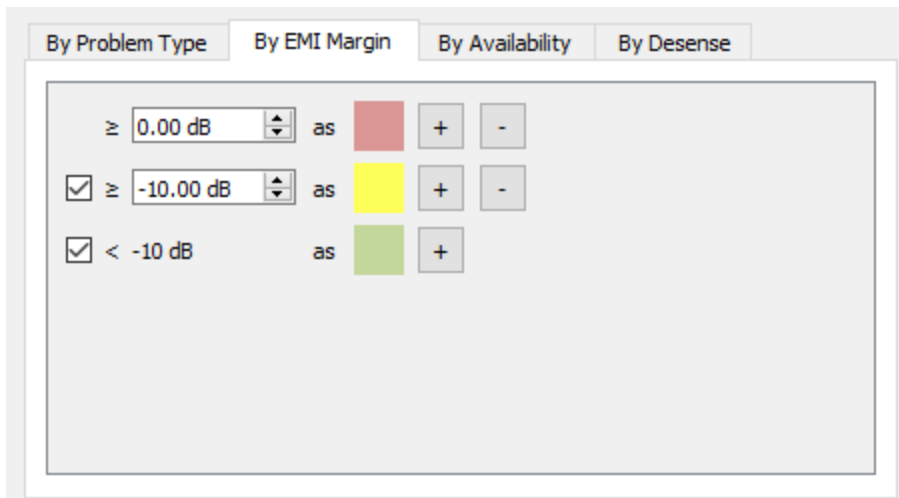

Results can also be filtered using the **By Problem Type** tab:

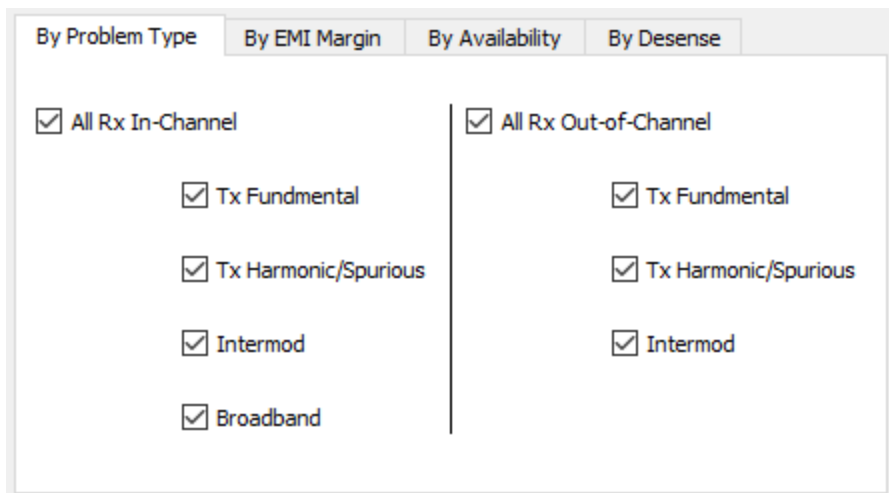

Feel free to explore how different filter combinations affect the simulation results.

EMIT can also isolate results by Tx/Rx. To view channel-specific results, select the HS Clock 80 Mbps band in the **Transmitters** window and the HR-DSSS Rx band in the **Receivers** window.

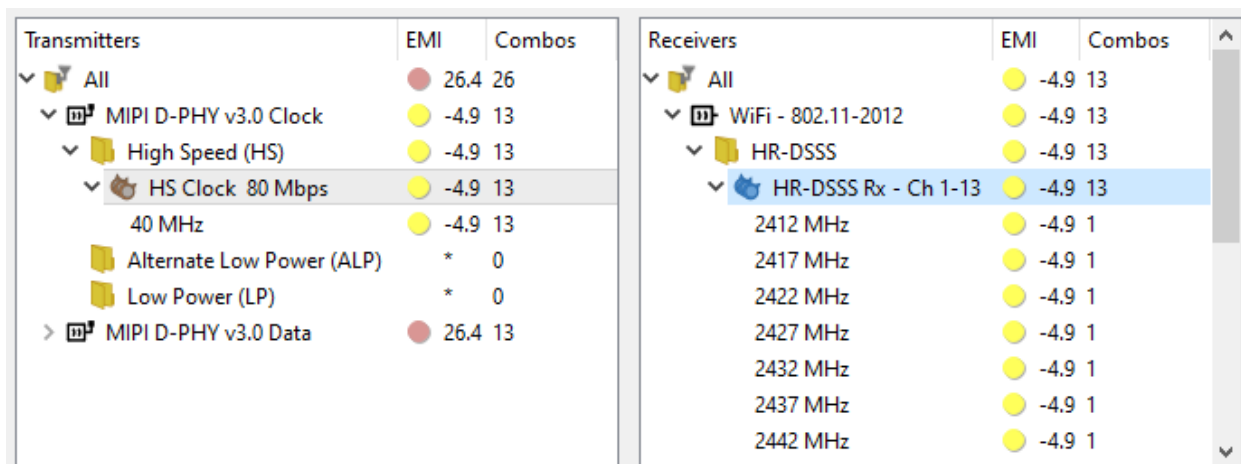

This updates the window to display channel-level interference results.

Next, modify the simulation to enable all data rates for both emitters. To do so, close the simulation window. Then open the configuration window for each emitter and enable all data rates:

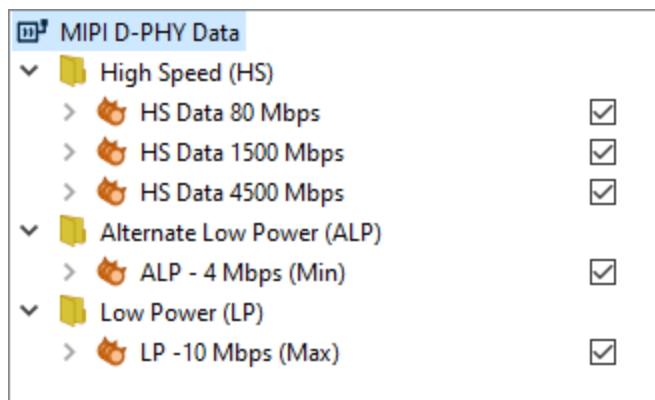
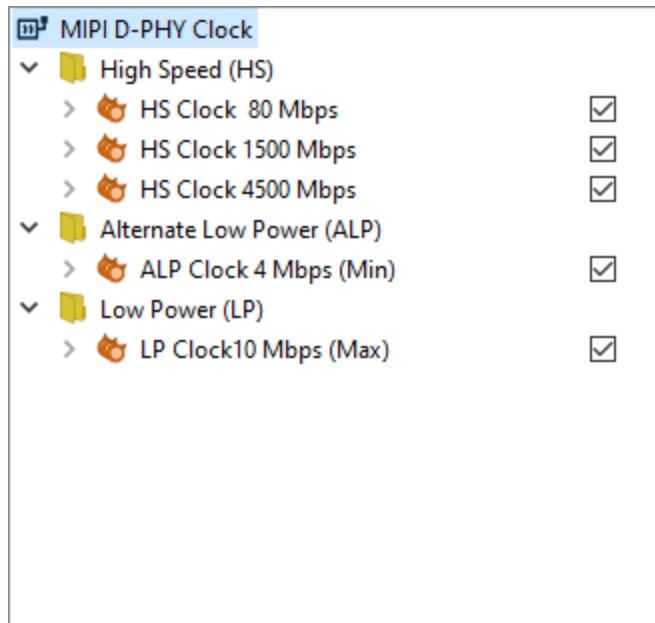

Changing the configuration of components in the design causes the previous results to have an X through them in the **Project Manager**:

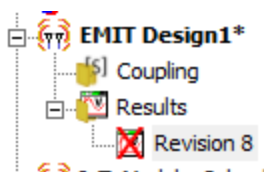

Old results can still be viewed, but they are no longer valid for the current modified design.

To run a new simulation:

## Getting Started with EMIT - Tutorial 8

- From the **Simulation** ribbon, click **Analyze**, or
- From the **Project Manager**, right-click **EMIT Design1** and select **Analyze**.

This will open the simulation window and create a new revision in the **Project Manager**.

Click **Run**.

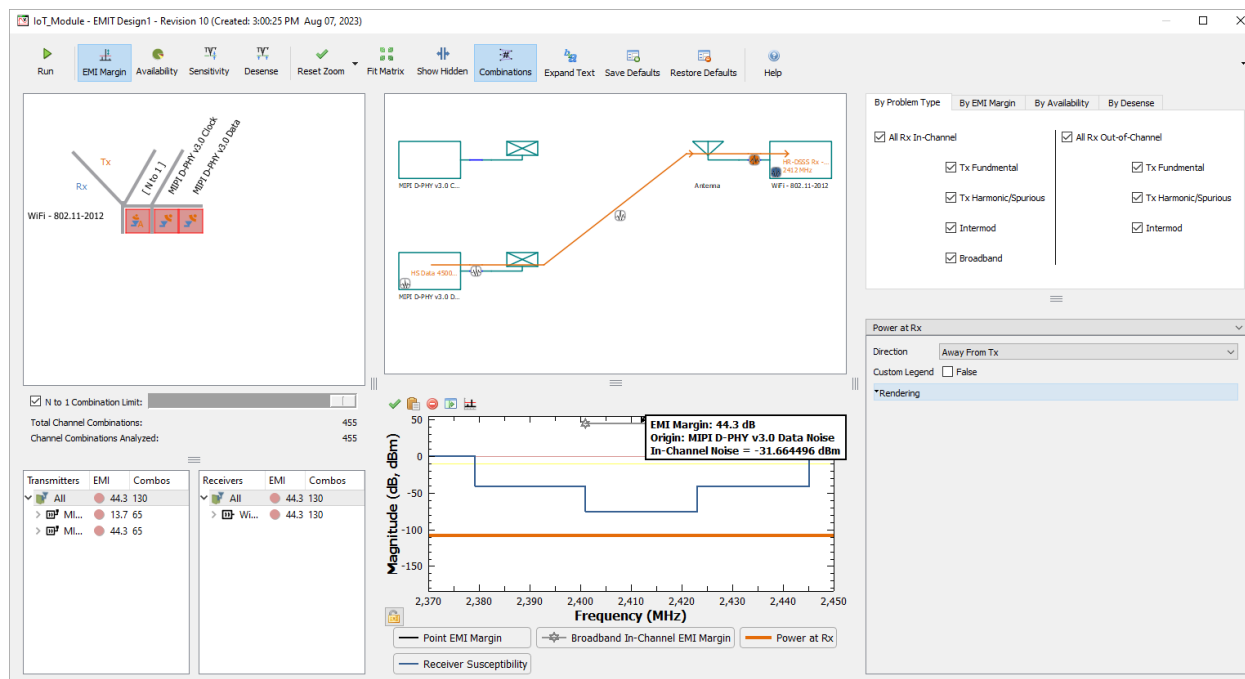

Notice that the results are different from the last simulation and that the EMI margin for the WiFi/Clock pairing has gotten worse. Similar to the last simulation, you can drill down into the results to further investigate the interference.

To isolate just the WiFi/Clock results, select that square in the scenario matrix.

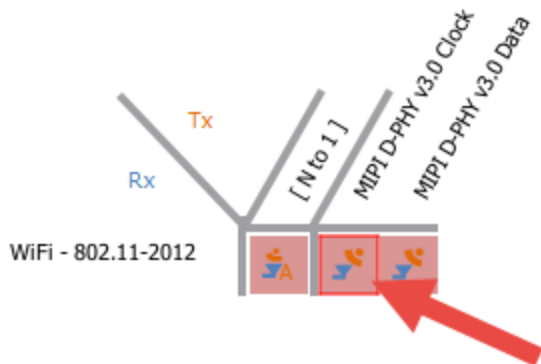

This updates the results to show only interference between that Tx/Rx pair.

The worst-case EMI margin is now 13.7 dB and it is caused by a Fundamental:

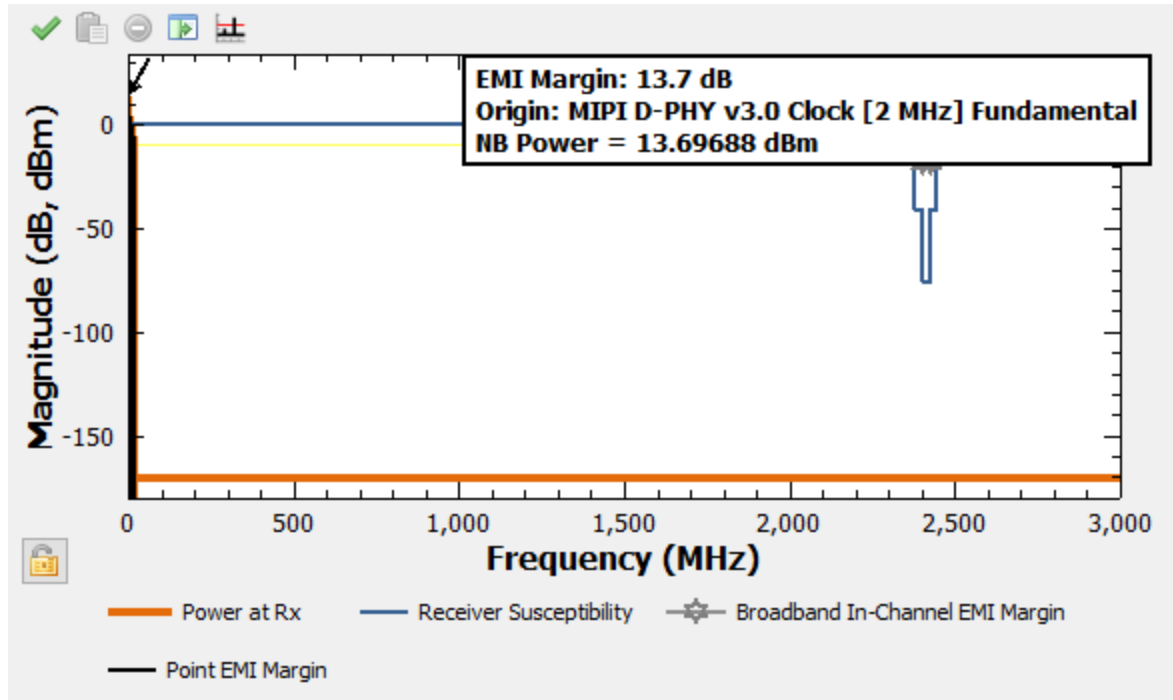

To further investigate this problem, select the **By Problem Type** tab. Under **All Rx Out-of-Channel**, deselect **Tx Fundamental**.

- All Rx Out-of-Channel
- Tx Fundamental
  - Tx Harmonic/Spurious
  - Intermod

The EMI Margin is now 4.2 dB and a problem still exists with a Harmonic:

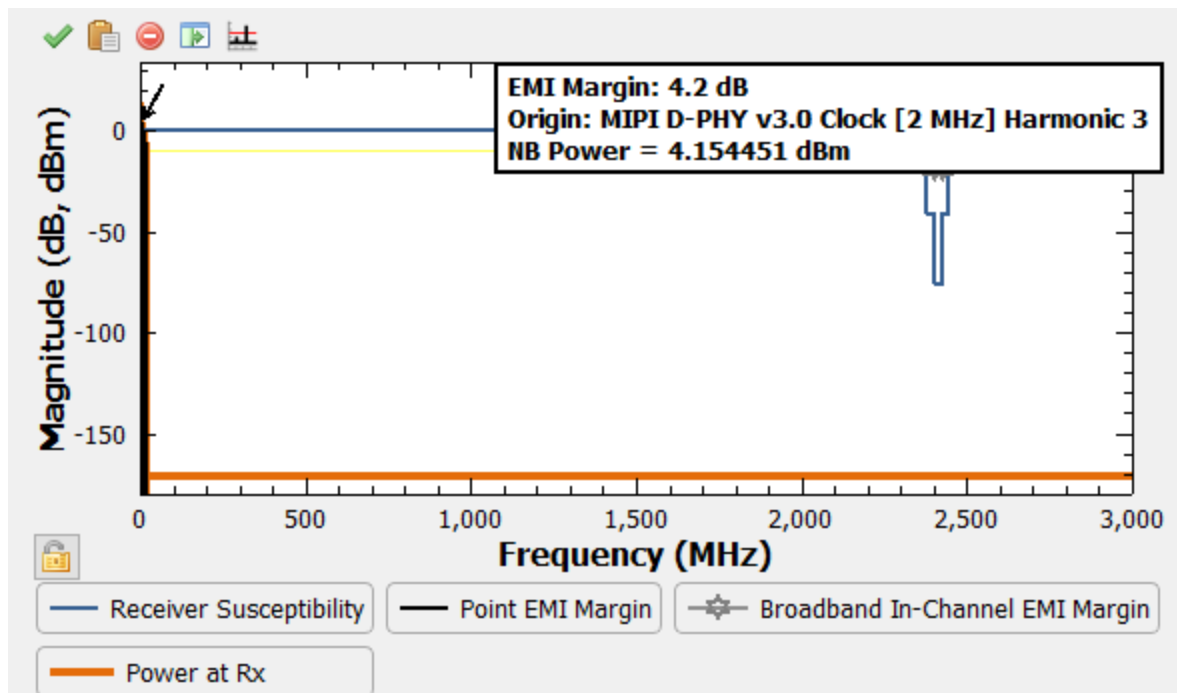

Deselect **Tx Harmonic/Spurious**:

- All Rx Out-of-Channel
  - Tx Fundamental
  - Tx Harmonic/Spurious
  - Intermod

The EMI Margin is now -18.5 dB and there is no longer a problem:

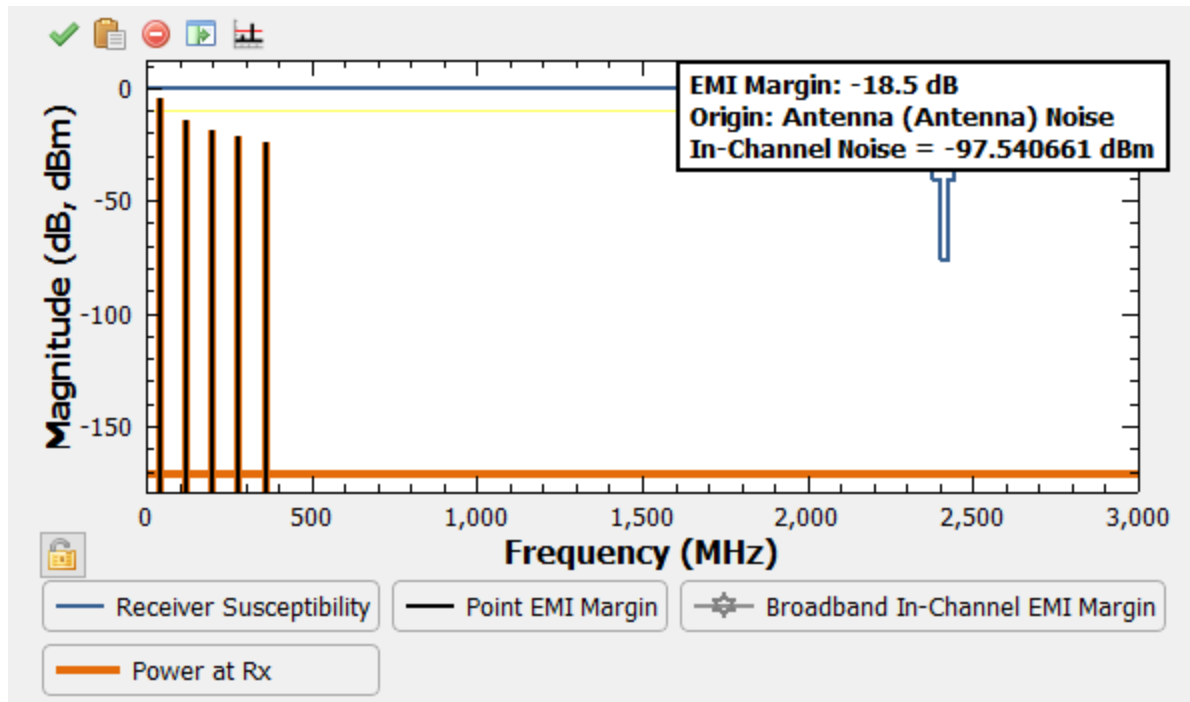

This is one way to isolate EMI problems. Another method is to use the results plot to zoom in and move the black arrow around to investigate problems.

Close the simulation window.

To mitigate the out-of-band problem, add a bandpass filter to the WiFi radio using the steps below.

Drag the antenna to the right to make space for the bandpass filter. Next, select the cable between the WiFi radio and the antenna and press **Delete**.

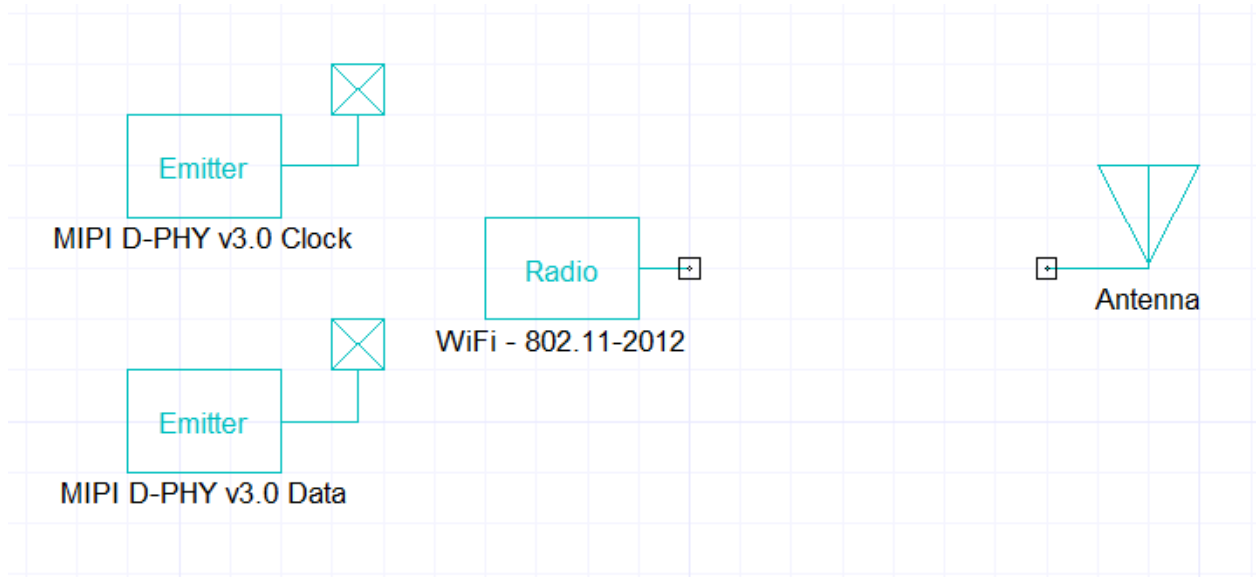

A preconfigured bandpass filter is available in the Personal Library we imported earlier. Drag and drop the **Filter** in the EMIT\_Training library into the schematic and connect it between the WiFi radio and the antenna:

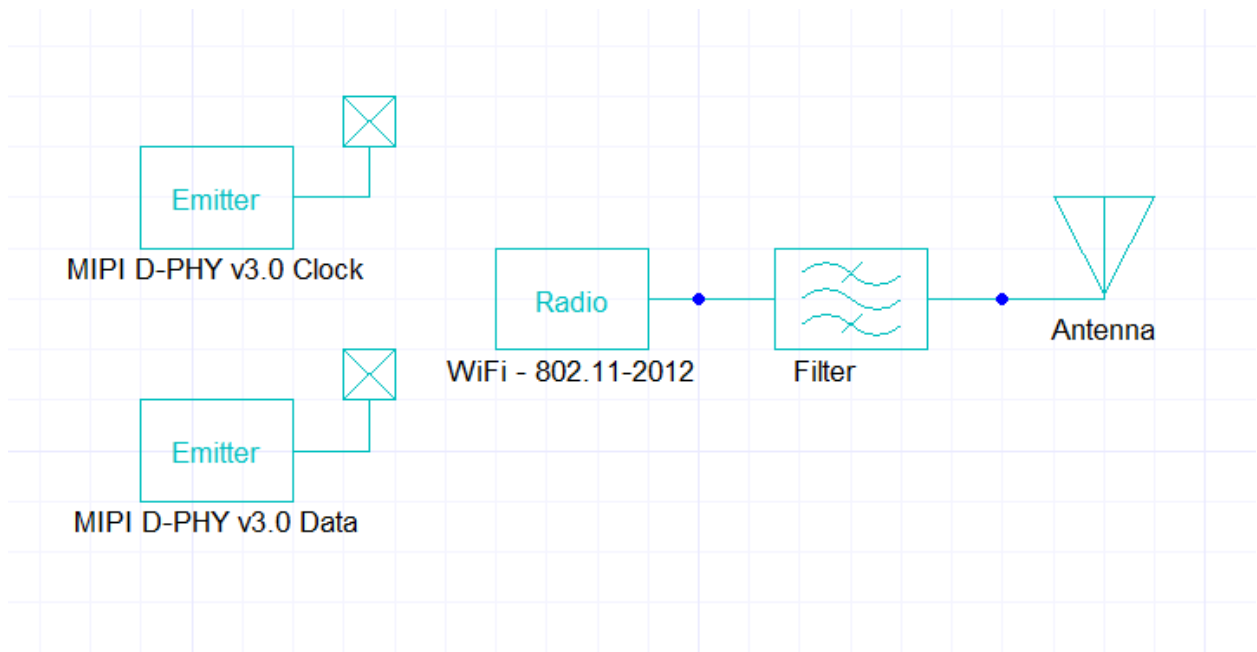

Relaunch the simulation window and notice that clock interference has come down significantly.

## 5 - Coupling

To open the Coupling Editor:

- From the **Project Manager**, right-click **Coupling** and select **Coupling Editor**, or
- From the **Simulation** ribbon, click **Coupling Editor**.

Initially, two values can be set in this window: Minimum Allowed Coupling and Global Default Coupling. The Global Default Coupling is initially set to 0 dB, which is not realistic, but it is not uncommon to run simulations with this value as a starting point.

For more realistic scenario, suppose we suspect we can achieve at least 20 dB of isolation. Change the **Global Default Coupling** value to -20 dB, click **Ok**, and rerun the simulation to see the impact of coupling on the results.

Next, bring in the Baseline HFSS design using coupling. From the **Project Manager**, click and drag the **Baseline** design into EMIT Design 1's **Coupling** folder.

If you are prompted to create antennas, select **No**, as this is already configured.

The **Coupling Editor** appears, populated with a list of terminals from the HFSS model listed as ports:

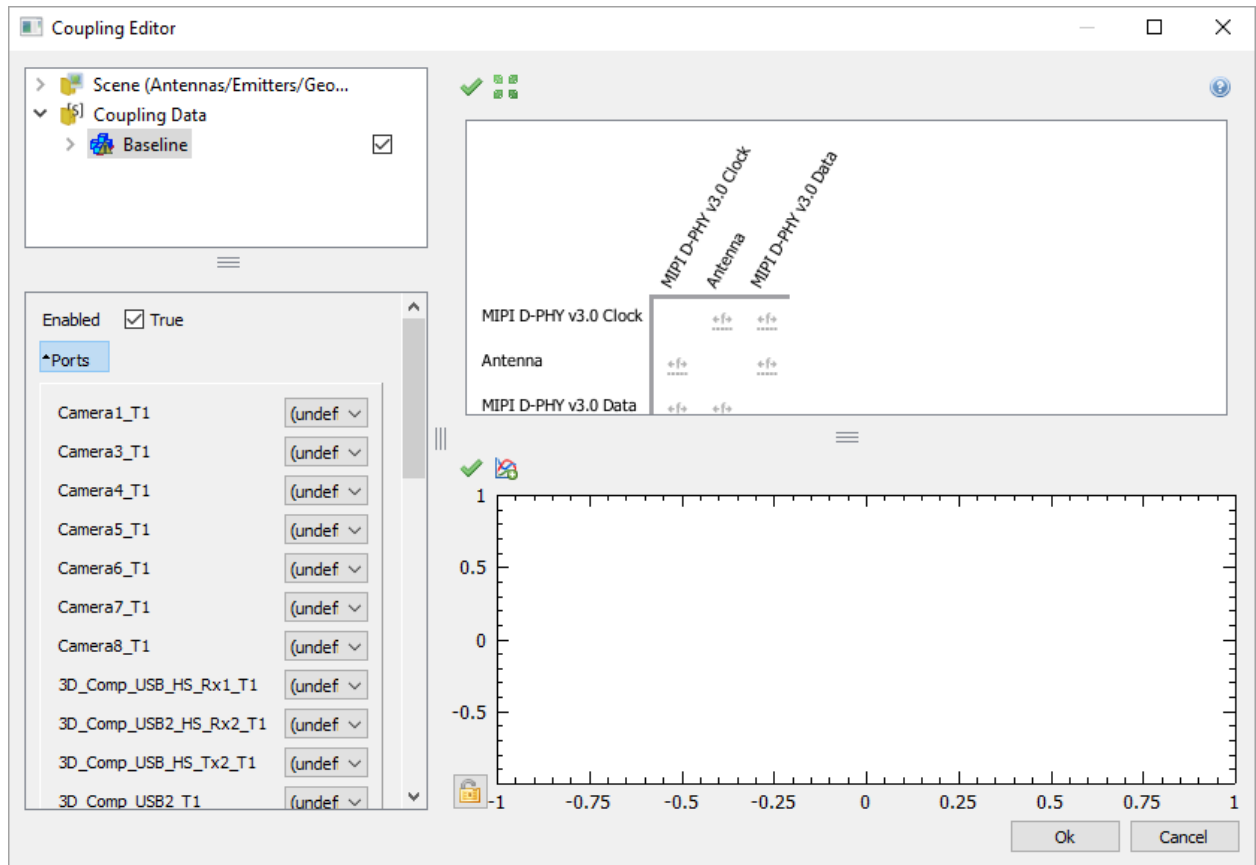

Use the drop-down menus to match terminals from the HFSS model to the EMIT model as follows:

- Camera1\_T1: MIPI D-PHY Clock
- Camera3\_T1: MIPI D-PHY Data
- WiFi\_Antenna\_T1: Antenna

The scenario matrix in the Coupling Editor updates with HFSS icons that can be clicked to display the coupling plot:

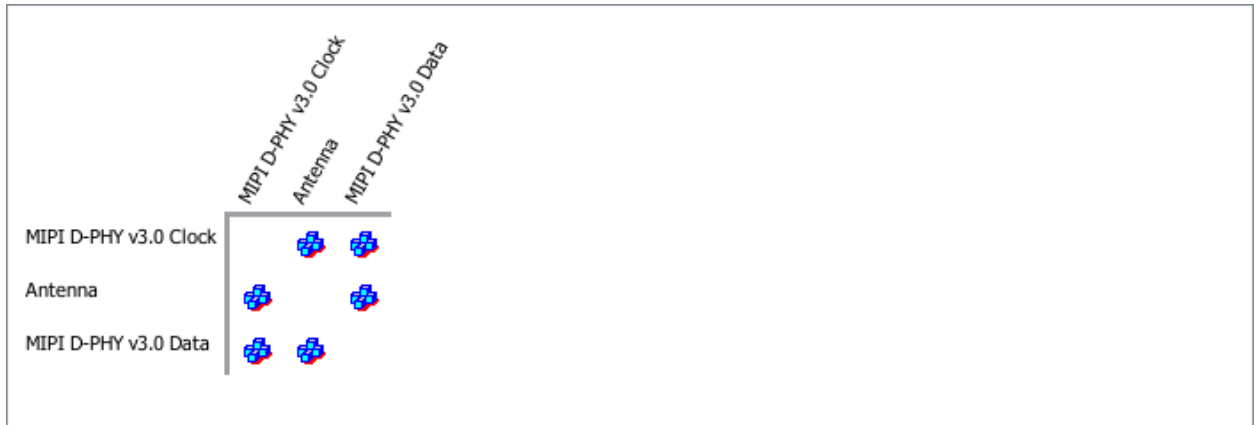

Click **Ok** and rerun the simulation.

The results show that the EMI margin is further improved. You can investigate and filter the results as we did previously.

To organize your results, delete all the results in the **Project Manager** that have an X through them by right-clicking and selecting **Delete**. Rename the most recent results to "Baseline 3Port" by right-clicking and selecting **Rename**.

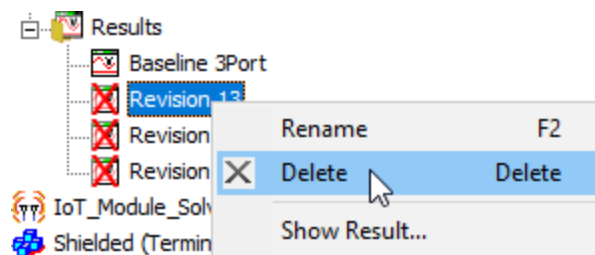

When all invalid results have been deleted, save the project.

Next, disconnect the Baseline coupling and connect the Shielded HFSS design. To do so, expand **Coupling** in the **Project Manager**. Right-click **Baseline** and select **Delete**. A red X appears through the "Baseline 3Port" results because the results are no longer valid; however, you can still view the results at any time to compare. Drag and drop **Shielded** into the **Coupling** folder.

If you are prompted to create antennas, select **No**, as this is already configured.

The **Coupling Editor** appears, populated with a list of terminals from the HFSS model listed as ports.

Use the drop-down menus to match terminals from the HFSS model to the EMIT model as before:

- Camera1\_T1: MIPI D-PHY Clock
- Camera3\_T1: MIPI D-PHY Data
- WiFi\_Antenna\_T1: Antenna

Click **Ok** and rerun the simulation.

This result shows the performance improvement achieved from usual mitigation strategies for improving isolation from unintended radiators.

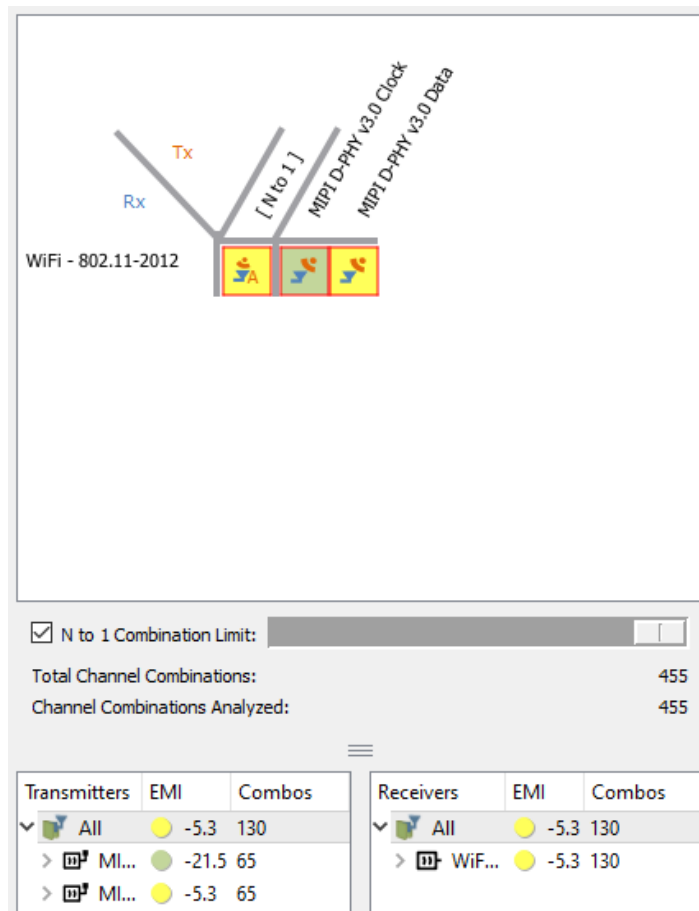

While this example only explored 3 defined ports, the IoT\_Module\_Solved EMIT design defines all ports from the HFSS model. To explore those results, select **File > Open Examples**. Navigate to EMIT \Tutorials \Tutorial 8 and select **Tutorial8.aedt**.

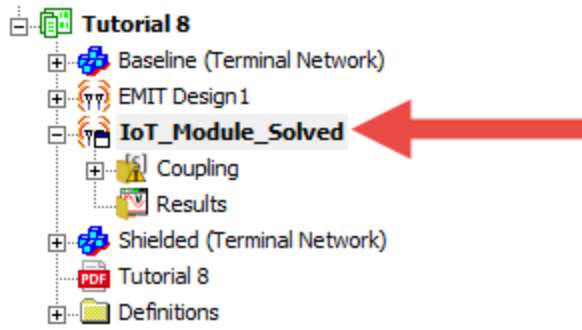

This concludes Tutorial 8.